

# BM SERIES METERS®

PRECISION POSITIVE DISPLACEMENT METERS



THE LEADER IN ACCURATE,  
LONG-LIFE, FUEL METERING

INDUSTRY LEADING ACCURACY  
(+/- .05%\*)

115 TO 3870 LPM  
(30 TO 1022 USGPM) FLOW RATES

\* subject to meter size

# FEATURES & BENEFITS

THE MOST ACCURATE AVIATION FUEL METERS IN THE WORLD

**Avery-Hardoll BM Series** flowmeters are precision made, positive displacement, liquid measuring instruments that maintain the highest level of accuracy over a lifetime of operation. Simplicity of design and accuracy has resulted in the Avery-Hardoll BM Series meters to being **the most preferred meters by aviation fueling operators and airlines** in international markets.\*

*\*According to the Global Aviation Fueling Survey 2015*

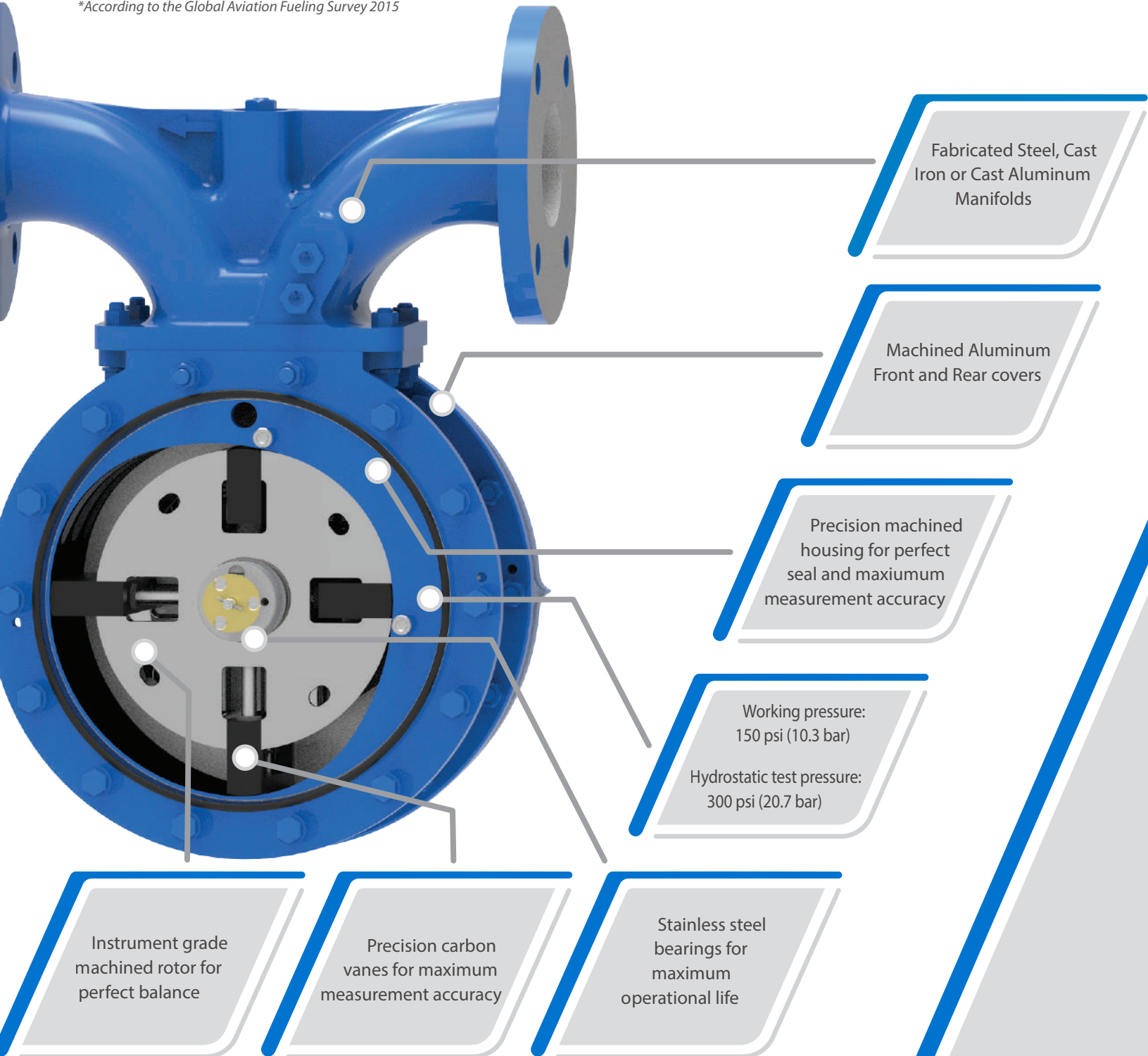

Fabricated Steel, Cast Iron or Cast Aluminum Manifolds

Machined Aluminum Front and Rear covers

Precision machined housing for perfect seal and maximum measurement accuracy

Working pressure:  
150 psi (10.3 bar)  
Hydrostatic test pressure:  
300 psi (20.7 bar)

Instrument grade machined rotor for perfect balance

Precision carbon vanes for maximum measurement accuracy

Stainless steel bearings for maximum operational life

# DIMENSIONAL DRAWINGS

## MECHANICAL METER ASSEMBLY DIAGRAM AND CROSS-SECTION

### AVAILABLE MODELS (INCLUDING DM SERIES)

BM Series bulkmeters are manufactured in three basic sizes with different ratings identified by a series number. The series numbers, sizes, flow rates, and a brief description of each series of meter are shown below.

#### TYPES OF FLOWMETERS

Series Number	Manifold		Flow Rate		General Description
	Inches	Millimeters	USGPM	Liters / Min	
BM250	2½	63	30 - 301	115 - 1140	Single Capsule Meters
BM950	3	76	34 - 361	130 - 1370	
BM450	3	76	52 - 541	200 - 2050	Double Capsule Meters
BM550	4	102	58 - 602	220 - 2280	
BM350	4	102	66 - 660	250 - 2500	Triple Capsule Meters
BM650	4	102	79 - 792	300 - 3000	
BM850	6	152	102 - 1022	387-3870	Triple Capsule Meter w/Aluminum Manifold for Aviation Applications
DM Series	4	102	66 - 660	250 - 2500	All Steel Meter, single body Intermittent flow rate 800 USGPM or 3000 Liters/Min

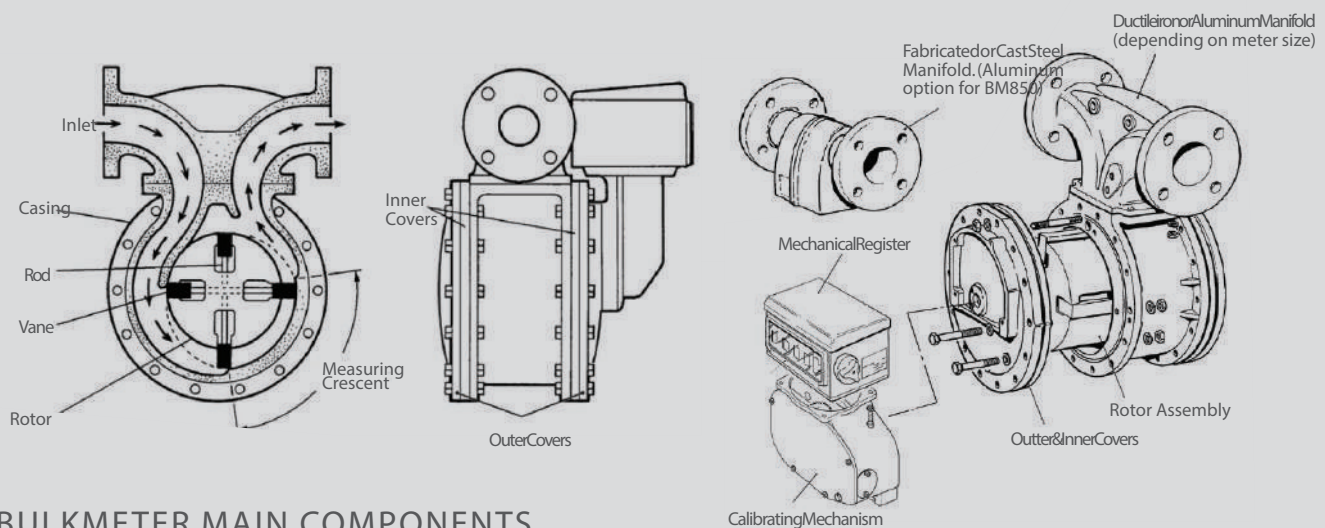

### BULKMETER MAIN COMPONENTS

- The BM Series bulkmeters consist of three main assemblies: the manifold, body assembly and rotor assembly
- The higher rating of the larger meters is achieved by bolting two or three body capsules together and fitting double or triple rotor assemblies with a larger manifold to suit
- A calibrating mechanism and mechanical register are also attached to the front end cover
- The calibrating mechanism can be replaced by a front cover incorporating a pulse transmitter when required for electronic systems, such as MASTERLOAD II™ or MASTERLOAD III™ registers

# BM METERS SPECIFICATIONS

PRECISION POSITIVE DISPLACEMENT BULK FUEL METERS

## Single Capsule Meter



Shown as bare shafted

Meter Series	Pipeline Size	Flow Rate			Flanges	
		USGPM	lpm	M <sup>3</sup> /h	Conform To	Material
BM250	2½" (63mm)	30 to 301	115 to 1140	7 to 68	ANSI 150 FF or RF	Ductile Iron Steel
BM950	3" (76mm)	34 to 361	130 to 1370	8 to 82	ANSI 150 FF or RF	Ductile Iron Steel

## Double Capsule Meter



Shown with AH pulser

Meter Series	Pipeline Size	Flow Rate			Flanges	
		USGPM	lpm	M <sup>3</sup> /h	Conform To	Material
BM450	3" (76mm)	52 to 541	200 to 2050	12 to 123	ANSI 150 FF or RF	Ductile Iron Steel
BM550	4" (76mm)	58 to 602	220 to 2280	14 to 136	ANSI 150 FF or RF	Ductile Iron Steel
BM350	4" (102mm)	66 to 660 740	250 to 2500 2800	15 to 150 168	ANSI 150FF or RF Intermittent Use	Ductile Iron Steel

## Triple Capsule Meter



Shown with mech. register

Meter Series	Pipeline Size	Flow Rate			Flanges	
		USGPM	lpm	M <sup>3</sup> /h	Conform To	Material
BM650	4" (102mm)	79 to 792	300 to 3000	18 to 160	ANSI 150FF or RF	Steel
BM750	6" (152mm)	79 to 792	300 to 3000	18 to 160	ANSI 150FF or RF	Steel
BM850	6" (152mm)	102 to 1022	387 to 3870	23 to 232	ANSI 150FF or RF Aviation Fuels	Aluminum FF Only

## ELECTRONIC REGISTER CALIBRATION

While conventional meters are calibrated at only one flow rate, MASTERLOAD II™ and MASTERLOAD III™ calibrates a range of flow rates to provide the highest level of accuracy allowing flexibility to configure each system to suit the requirements of their specific application.

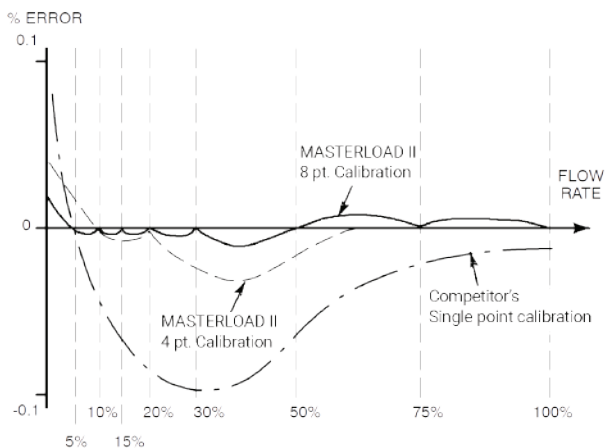

## ELECTRONIC AND MECHANICAL OPTIONS



BM950 with POD pulser



BM950 with POD pulser and MASTERLOAD.iQ



BM950 with LC Mechanical Calibrator and Register

# PHYSICAL CHARACTERISTICS

## DIMENSIONS AND CALIBRATION TESTING

Single Capsule Meter

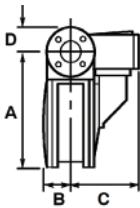

BM	Flange Bolt Holes		Manifold Overall Dimensions		Meter Dimensions								Approx. Weight of Basic Meter		
	No. Off	Size			A		B		C		D				
		mm.	in.	mm.	in.	mm.	in.	mm.	in.	mm.	in.	mm.	in.	kg.	lbs.
250	4	19	.75	356	14	408	16.1	107	4.2	285	11.2	89	3.5	70	54
	4	19	.75	400	15.75	427	16.8	107	4.2	285	11.2	89	3.5		
950	4	19	.75	356	14	408	16.1	107	4.2	285	11.2	95	3.75	70	54
	4	19	.75	400	15.75	427	16.8	107	4.2	285	11.2	95	3.75		

Double Capsule Meter

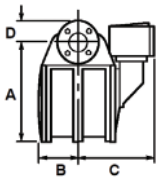

BM	Flange Bolt Holes		Manifold Overall Dimensions		Meter Dimensions								Approx. Weight of Basic Meter		
	No. Off	Size			A		B		C		D				
		mm.	in.	mm.	in.	mm.	in.	mm.	in.	mm.	in.	mm.	in.	kg.	lbs.
450	4	19	.75	400	15.75	405	15.9	170	6.7	348	13.7	95	3.75	100	220
	4	19	.75	400	15.75	427	16.8	170	6.7	348	13.7	95	3.75		
350	8	19	.75	400	15.75	420	16.5	170	6.7	348	13.7	115	4.5	112	247
	550	8	19	.75	400	15.75	427	16.8	170	6.7	348	13.7	115		

Triple Capsule Meter

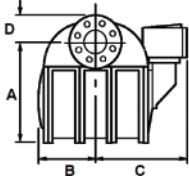

BM	Flange Bolt Holes		Manifold Overall Dimensions		Meter Dimensions								Approx. Weight of Basic Meter		
	No. Off	Size			A		B		C		D				
		mm.	in.	mm.	in.	mm.	in.	mm.	in.	mm.	in.	mm.	in.	kg.	lbs.
650	8	19	.75	400	15.75	427	16.8	233	9.2	411	16.2	115	4.5	126	278
850	8	22	.875	400	15.75	427	16.8	233	9.2	411	16.2	140	5.5	136	300

### MECHANICAL CALIBRATION

Calibration adjustment is stepless, with no necessary gear changing. All meters are tested at a range of flow rates before dispatch. Test certificates available upon request.

- Fluid used for testing: Kerosene
- Specific gravity: at 15°C = 0.8
- Viscosity at 15°C = 2.4 centistokes.

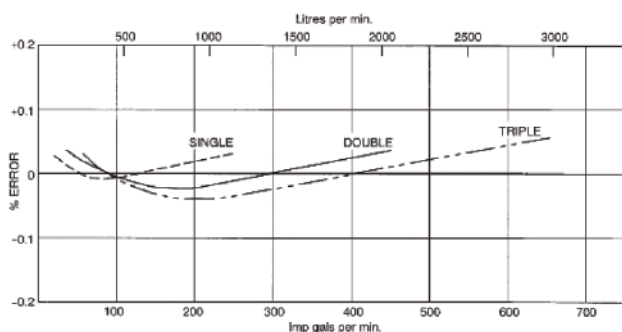

Typical accuracy curves for the basic meter build (10:1 turndown)

### WORKING SPECIFICATIONS

- Maximum working pressure: 150 psi (10.3 bar)
- Test pressure: 300 psi (20.7 bar)
- Temperature range: -40°C to 100°C
- Volume per revolution:
  - 2.27 litres / 0.60 USG (single capsule)
  - 4.54 litres / 1.20 USG (double capsule)
  - 6.82 litres / 1.80 USG (triple capsule)
- Typical accuracy: +/- 0.05%
- Repeatability: 0.02%

# PERFORMANCE

## PERFORMANCE AND PRESSURE DROP CALCULATIONS

### PRESSURE DROP CHART (PSI)

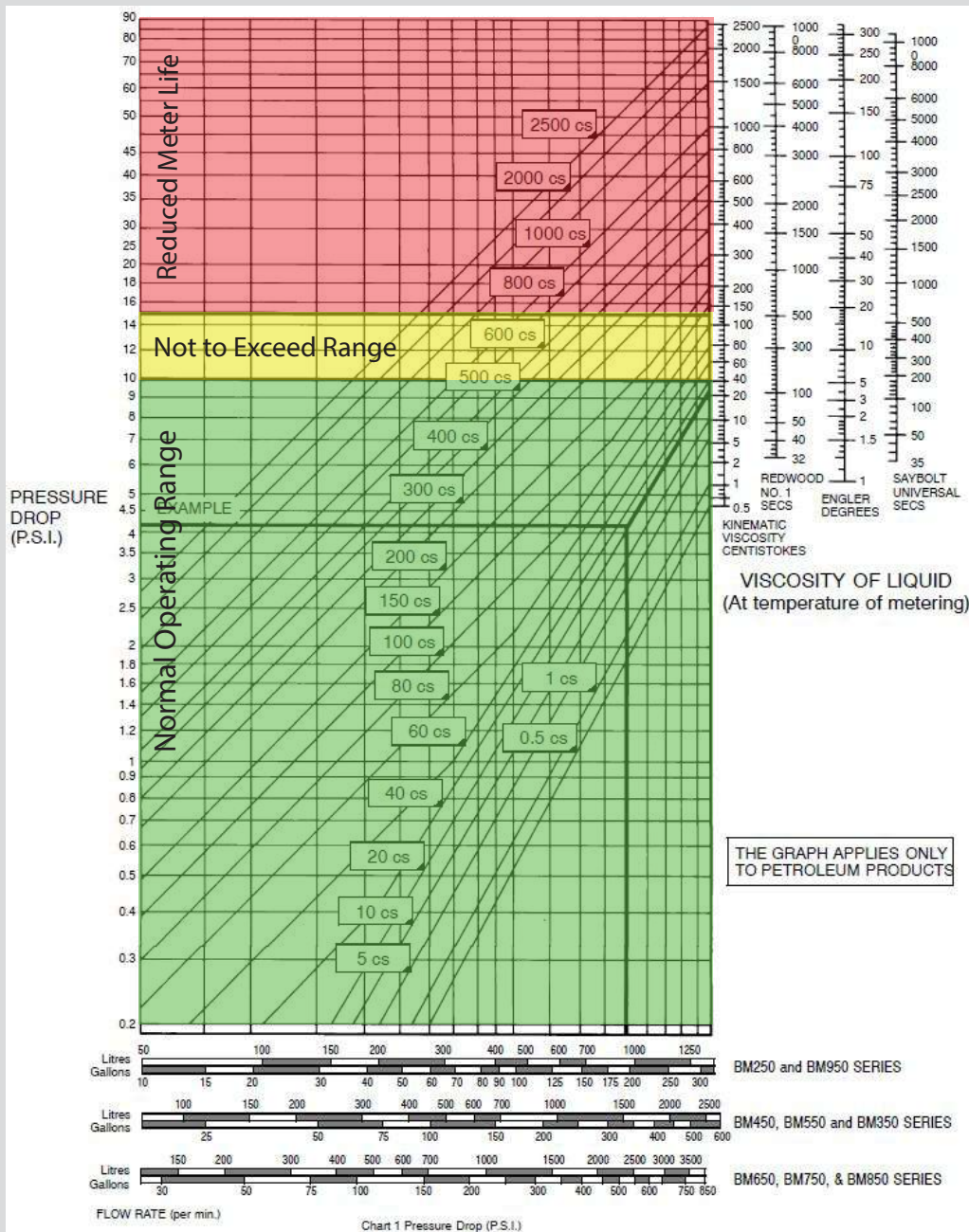

### VISCOUS PRODUCTS

Avery-Hardoll bulkmeters can be used on all petroleum products of all viscosities. However, there is an increase in pressure drop with more viscous fuels, which under normal circumstances will limit the maximum flow rate obtainable.

It is recommended that the pressure drop through a bulkmeter should not exceed 15 psi (1 bar), above which the load on the bearings will start to cause wear.

Consequently when using products with viscosities above 100 centistokes (at operating conditions), it is necessary to reduce the maximum permitted flow rate. As a guide, it is suggested that the pressure drop through the meter should not exceed 10 psi (0.7 bar) for continuous running at maximum speed or 15 psi (1 bar) for continuous running at half speed.

The low pressure drop for the BM Series of Avery-Hardoll bulkmeters is displayed on the left.

# REGISTRATION & ACCESSORIES

## ELECTRONICS REGISTRATION



### MASTERLOAD.iQ™ REGISTER

- ATEX ZONE 2 approved register
- Configurable screens and user prompts
- dP, DENSITYiQ, water detection with SENSEiQ
- Wireless communication via Bluetooth and Wi-Fi



### MASTERLOADx.iQ™ REGISTER

- ATEX ZONE 1 approved register
- Configurable screens and user prompts
- dP, DENSITYiQ, water detection with SENSEiQ technology
- Wireless communication via Bluetooth and Wi-Fi

## ACCESSORIES



FUELiQ Android Application  
for ultimate control of fueling data



Temperature Volume  
Compensation (TVC)



Differential Pressure Transducer



2 Channel LC POD pulser



Large Digital Remote Display



Paper Receipt Printer



### BULK FUEL FLOWMETERS

Avery-Hardoll flowmeters are precision made, positive displacement, liquid measuring instruments; considered the most accurate aviation fuel flowmeters in the world.



### ELECTRONIC REGISTRATION

MASTERLOAD.iQ™ the latest innovation in electronic registration approved to ATEX Zone 2 hazardous areas.



MASTERLOADx.iQ™ is the ATEX Zone 1 extension to MASTERLOAD.iQ for Zone 1 hazardous areas.

To learn more about Avery-Hardoll products, visit: [AveryHardoll.com](http://AveryHardoll.com)



Liquid Controls offers a full range of:

- M Series Meters
- MS Series Meters
- Electronic Registration
- Valves
- Air Eliminators & Strainers
- Fueling Accessories
- Wireless Data Management

Liquid Controls proudly manufactures the Avery-Hardoll and LC brand meters and is the leading manufacturer of positive displacement flowmeters and fuel data management systems in the world.

To learn more about what LC can offer you visit: [LCMeter.com](http://LCMeter.com)



BMSeriesBrochure\_Rev01102019  
© Copyright 2019 Liquid Controls LLC All Rights Reserved.

Distributed by: